

Profielplaten → Gevel → Golf

SAB 18/988

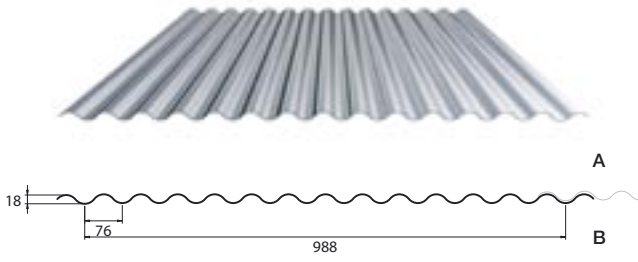

Staal		Aluminium	
mm	kg/m ²	mm	kg/m ²
0,63	6,26	0,70	2,39
0,70	6,95	0,80	2,73
0,75	7,45	1,00	3,42
0,88	8,74		
1,00	9,93		

Aanbevolen maximale lengte: 12 m

SAB 27/1000

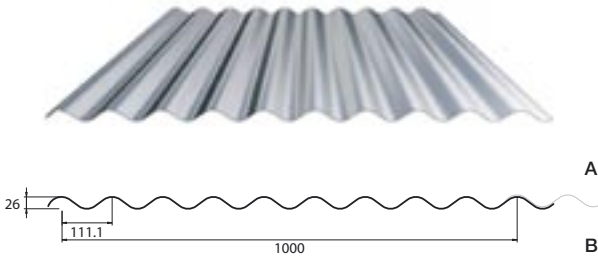

Staal		Aluminium	
mm	kg/m ²	mm	kg/m ²
0,63	6,30	0,70	2,41
0,70	7,00	0,80	2,75
0,75	7,50	1,00	3,44
0,88	8,80		
1,00	10,00		

Aanbevolen maximale lengte: 12 m

SAB 42/960

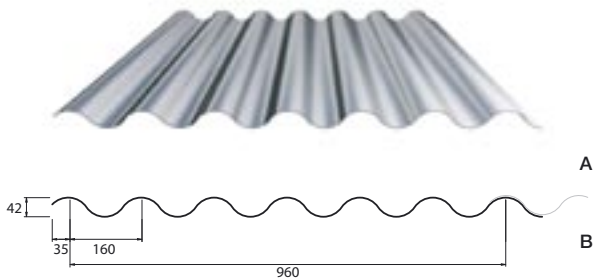

Staal		Aluminium	
mm	kg/m ²	mm	kg/m ²
0,63	6,55	0,70	2,51
0,70	7,29	0,80	2,87
0,75	7,81	1,00	3,58
0,88	9,16		
1,00	10,40		

Aanbevolen maximale lengte: 12 m

Profielplaten → Gevel → Trapezium

SAB 19/1050

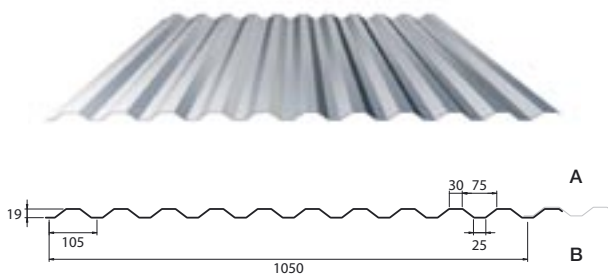

S	ALU	RVS			
Staal		Aluminium			
mm	kg/m ²	mm	kg/m ²		
0,63	5,88	0,70	,25		
0,70	6,53	0,80	2,57		
0,75	7,00	1,00	3,21		
0,88	8,21				
1,00	9,34				

Aanbevolen maximale lengte: 12 m

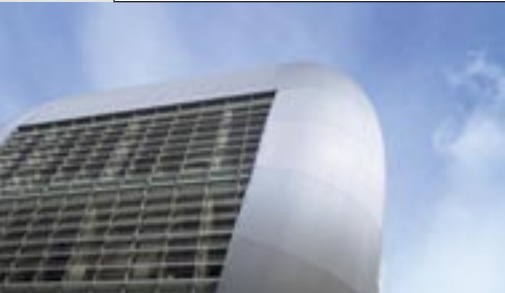

SAB 30/1100

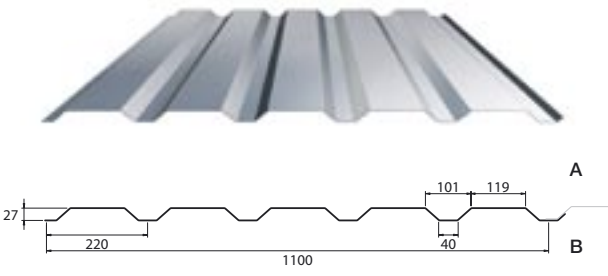

S	ALU	RVS			
Staal		Aluminium			
mm	kg/m ²	mm	kg/m ²		
0,63	5,62	0,70	2,15		
0,70	6,24	0,80	2,45		
0,75	6,69	1,00	3,07		
0,88	7,84				
1,00	8,91				

Maximale lengte: 12 m

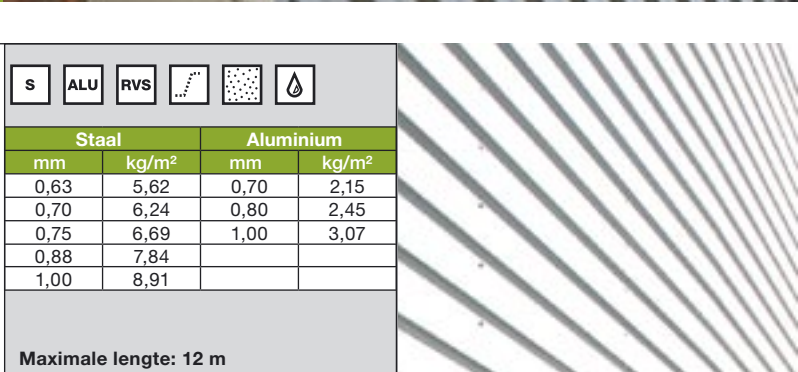
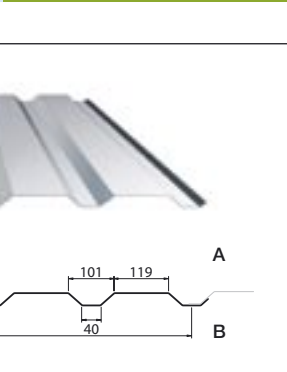
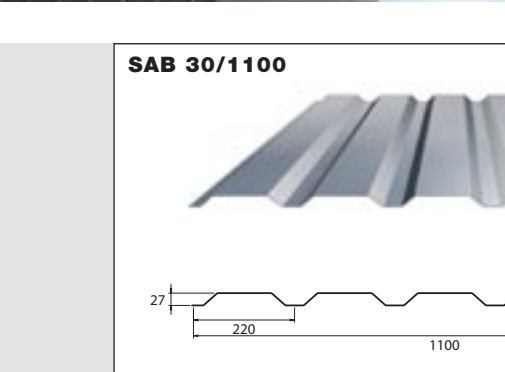

SAB 35/1035

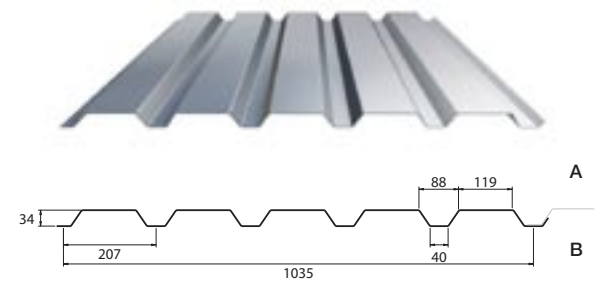

S	ALU	RVS			
Staal		Aluminium			
mm	kg/m ²	mm	kg/m ²		
0,63	5,97	0,70	2,28		
0,70	6,63	0,80	2,61		
0,75	7,11	1,00	3,26		
0,88	8,34				
1,00	9,48				

Aanbevolen maximale lengte: 12 m

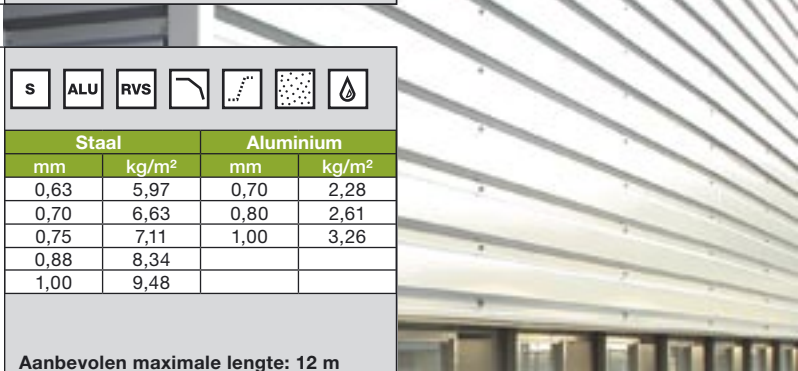
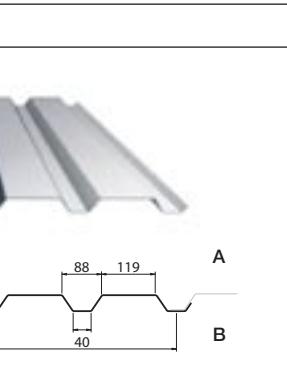
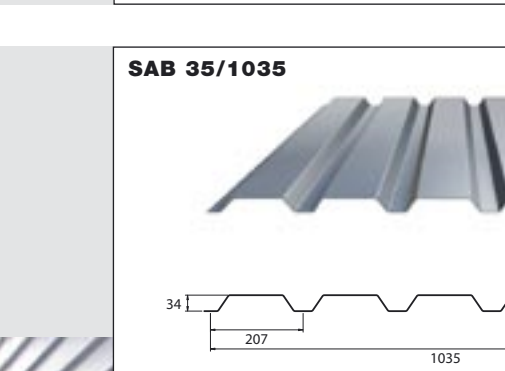



SAB 40/915

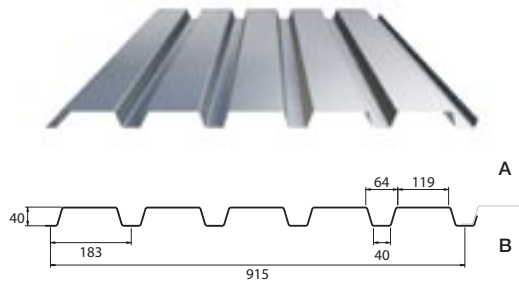

Staal		Aluminium	
mm	kg/m ²	mm	kg/m ²
0,63	6,75	0,70	2,58
0,70	7,50	0,80	2,95
0,75	8,04	1,00	3,69
0,88	9,43		
1,00	10,72		

Aanbevolen maximale lengte: 12 m

SAB 45/900

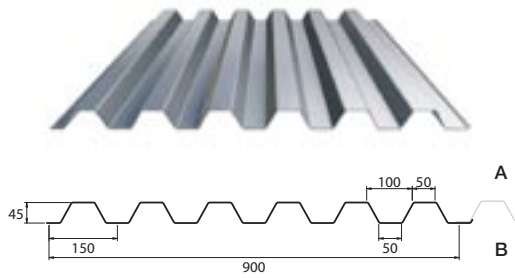

Staal		Aluminium	
mm	kg/m ²	mm	kg/m ²
0,63	7,00	0,70	2,68
0,70	7,78	0,80	3,06
0,75	8,33	1,00	3,82
0,88	9,78		
1,00	11,11		

Aanbevolen maximale lengte: 12 m



SAB 50/1000

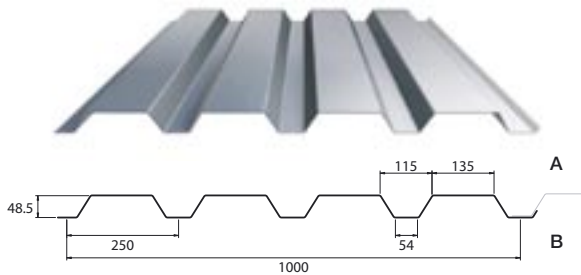

Staal		Aluminium	
mm	kg/m ²	mm	kg/m ²
0,63	6,30	0,70	2,41
0,70	7,00	0,80	2,75
0,75	7,50	1,00	3,44
0,88	8,80		
1,00	10,00		

Aanbevolen maximale lengte: 12 m

SAB-twin 33/1000

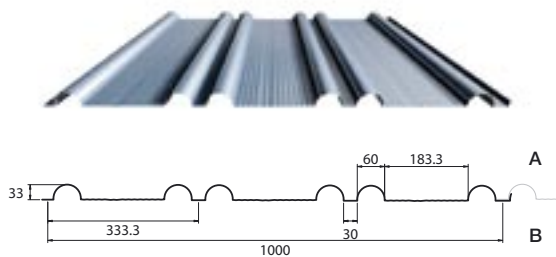

S ALU

Staal		Aluminium	
mm	kg/m ²	mm	kg/m ²
0,75	7,50	0,70	2,41
0,88	8,80	0,80	2,75
1,00	10,00	1,00	3,44

Aanbevolen maximale lengte: 12 m



SAB PP 37/460

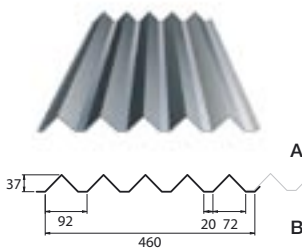

S ALU

Staal		Aluminium	
mm	kg/m ²	mm	kg/m ²
0,75	8,00	0,80	2,94
0,88	9,39	1,00	3,67
1,00	10,67		

Maximale lengte: 6 m

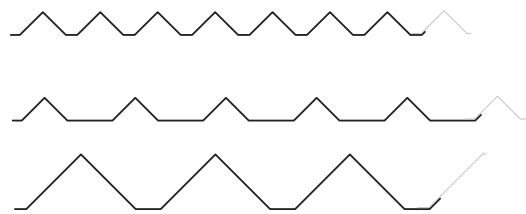

Afwijkende profiel geometrieën op aanvraag, nevenstaande profileringen behoren ondermeer tot de mogelijkheden.

